



PRS-4

Sutera USA LLC - 55 Commerce Center, Greenville SC. 29615 USA
 Sutera Canada Inc. - 700 Rupert Street, Waterloo ON. N2V 2B5 CANADA

Description	Designed to safely and securely contain waste in-ground, where it is kept cool and reduces odors. The containment is fire proof, animal proof and impact resistant, by utilizing concrete and steel construction. Serviced by vertical lift crane truck.
Materials	<p>Steel Lid:</p> <ul style="list-style-type: none"> - Carbon steel c/w 3 part powder coat finish - All fastening hardware is stainless steel <p>Precast Concrete Containment Well:</p> <ul style="list-style-type: none"> - High strength, steel reinforced concrete with high sulfate resistant cement - Overall mass exceeds the natural forces of hydrostatic pressures (will not float) - All precast risers and bases contain 2 swift lift hook anchors for lifting <p>Reusable Containment Bag</p> <ul style="list-style-type: none"> - 18 oz. PVC coated polyester bag - Heavy duty bag hardware for cinching the bag closed
Technical Data	<p>Dimensions:</p> <p>Large Steel Lid = 61.25" dia. (1556 mm), Convex Curve = +1.0" (25 mm) Steel Access Lid Opening = 9" dia. (229 mm) Access height above finished grade = 42" (1067 mm) Precast Concrete Inside Dia. = 48" (1219 mm), Outside Dia. = 58" (1473 mm) Precast Concrete Inside Depth = 96" (2438 mm), Overall Height = 102" (2591 mm)</p> <p>Weights:</p> <p>Steel Lid = 450 lbs (204 kg) Precast Concrete: Monobase = 5079 lbs (2304 kg), Riser = 3600 lbs (1633 kg)</p> <p>Volume:</p> <p>Containment Capacity = 3.72 cu.yds (2847 liters)</p>
Maintenance Instructions	<p>Spray all exposed steel components with Krown Rust Proofing & Lubricant every 12 months. Do not wipe off immediately, allow product to penetrate for 24 hrs.</p> <p>Spray White Lithium Grease to the following locations every three months, more frequently in colder weather.</p> <ul style="list-style-type: none"> - key hole of locking mechanism <p>Note: White Lithium Grease does not freeze in cold temperatures</p> <p>Entire Exterior of unit should be kept clean with soap and water, clean as required.</p>

For more information about this product visit www.sutera-inground.com or email contact@sutera-inground.com

PRS-4

Sutera USA LLC - 55 Commerce Center, Greenville SC. 29615 USA
Sutera Canada Inc. - 700 Rupert Street, Waterloo ON. N2V 2B5 CANADA

Top View

NOTE: ALL DIMENSIONS SHOWN ARE IN INCHES UNLESS OTHERWISE SPECIFIED

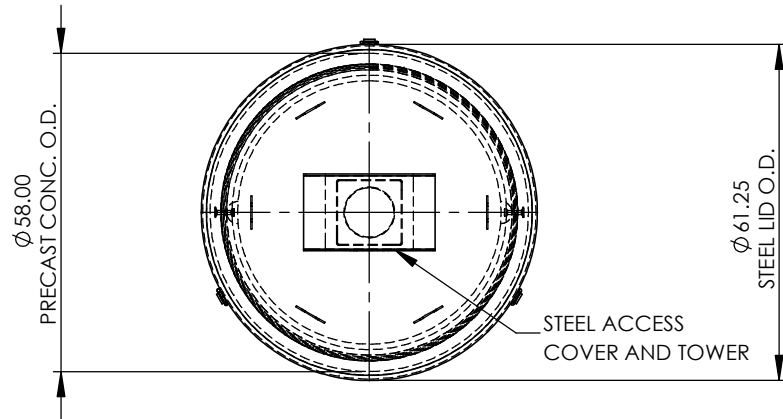

Front View

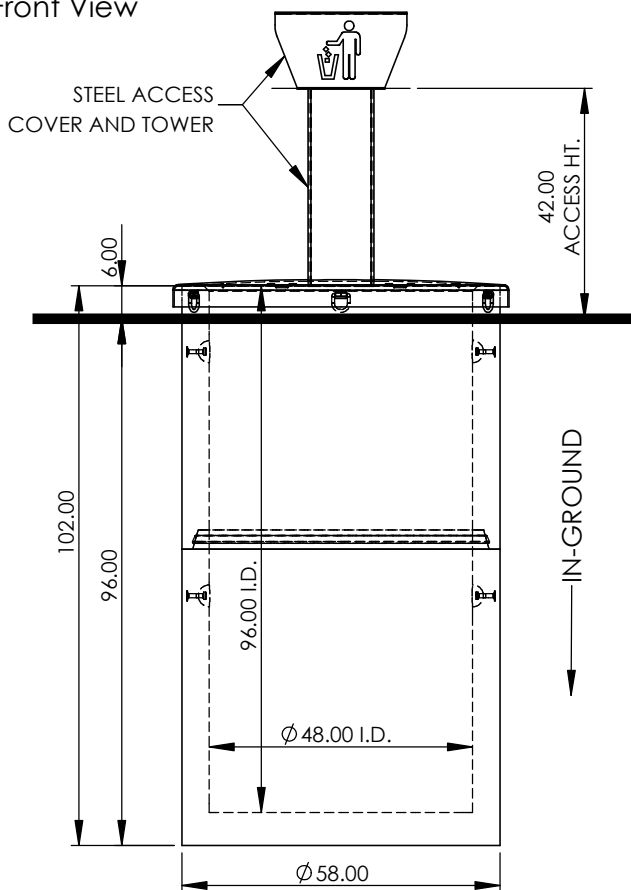

Section View

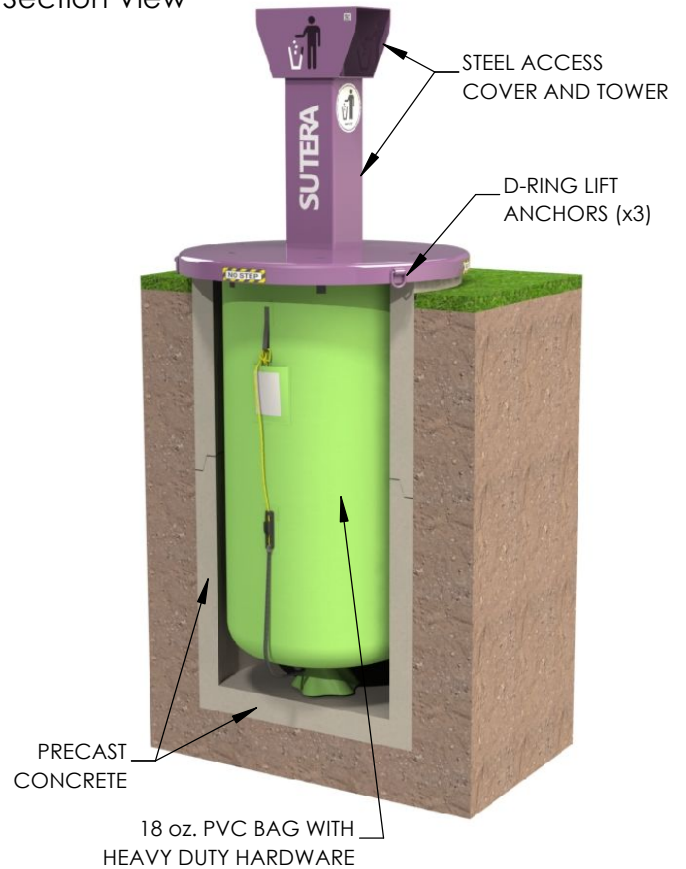

For more information about this product visit www.sutera-inground.com or email contact@sutera-inground.com